



M-D Marina District

This page intentionally left blank.

§120-77.2**M-D Marina District****§120-77.2**

This Section provides regulatory standards governing building form, land use and new public open spaces within the Marina District (M-D). This district was created in response to the opportunities for major improvements to the Port of Rochester area that will be made possible by the construction of a new marina, the extension of River Street and the reconfiguration and reconstruction of other existing streets and blocks. The Marina District will be the next chapter in Charlotte's history as a lakeshore resort community. The ultimate goal of the Marina District code is to foster the creation of a district that will attract visitors because it is distinctive and memorable, and will endure because it is valued by residents and visitors alike. This Section incorporates a Form-Based Code intended to govern the development of PARCELS I, II, III and the Terminal Building site, which have been designated for private development. In the Marina District, the primary emphasis is placed upon the physical form of buildings, civic spaces and placemaking. While land uses are regulated, they are a secondary focus within this district. The principal components of the code are described herein:

- **Regulating Plan (§120-77.2A).** The REGULATING PLAN is the key to the Marina District Form-Based Code. It indicates the Building Types and Frontage Types permitted for each PARCEL and provides other specific information necessary to create the physical form and character desired for the Marina District.
- **Building Envelope Standards (§120-77.2B).** The BUILDING ENVELOPE STANDARDS establish the minimum and maximum three dimensional spatial envelope within which a building may be constructed, as well as requirements for a limited number of permitted or required building elements, such as storefronts and windows. There are general provisions applicable to all buildings as well as specific standards for each Frontage Type and Building Type. The intent of the BUILDING ENVELOPE STANDARDS is to shape public space through placement and envelope controls on buildings that frame public rights-of-way and open spaces. The Building Envelope Standards also provide for uses that are permitted on ground stories and in upper stories correlated to each Building Type and Frontage Type.
- **Building Function (Use) Standards (§120-77.2C).** The Building Function Standards establish categories of uses that are permitted anywhere within the Marina District, categories that are specially permitted and categories that are prohibited.
- **Civic Square Standards (§120-77.2D).** The CIVIC SQUARE Standards establish the basic parameters governing the required CIVIC SQUARE on PARCEL I.
- **Parking and Loading Standards (§120-77.2E).** The Parking and Loading Standards establish the basic parameters governing the placement of and access to parking facilities. The standards include requirements for permanent parking created in conjunction with new buildings, interim surface parking on undeveloped portions of PARCELS I, II and III and bicycle parking.

- **Architectural Standards (§120-77.2F).** The Architectural Standards are intended to provide a minimal level of quality and to promote a coherent character throughout the Marina District. The Architectural standards govern each building's elements, regardless of Building or Frontage Type, and set parameters for acceptable materials, configurations and techniques.
- **Review and Approval Process (§120-77.2G).** The Review and Approval Process includes procedures for the approval of proposed developments that are not fully compliant with the requirements of the Marina District Form-Based Code. All proposed developments that are fully compliant will be approved administratively.
- **Definitions (§120-77.2H).** Words and/or terms used in this Section that are not defined in §120-208 or have a different definition than that shown in §120-208 are included in this Section. Such words and/or terms will appear in the text of §120-77.2 in a SMALL CAPITALS format.















A

Regulating Plan

M-D Marina District

This page intentionally left blank.

A. Regulating Plan

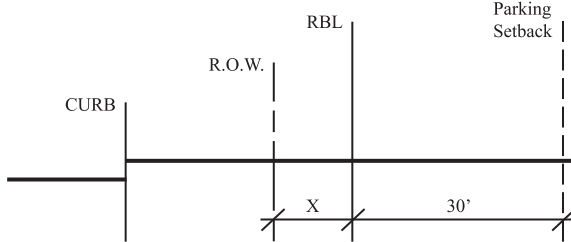
	District Boundary	<p>A= 25' Minimum Setback</p> <p>B= 15' Minimum Setback</p> <p>C= 35' Maximum</p> <p>D= 2' Min., 50' Max. Setback</p> <p>E= 2' Min, 135' Max. Setback</p> <p style="text-align: center;"><u>KEY TO PARCEL III</u></p>	
	Parcel Boundary		
	Required Build-To Line		
	Required Frontage Zone		
	Parking Setback Line		
	Mandatory Commercial Frontage		
	Allowable Parking/Loading Ingress/Egress Location		
	Building Type 'A' Permitted		<p>A= 5' Minimum</p> <p>B= 30' Minimum</p> <p>C= 50' Maximum</p> <p>D= 2' Minimum Setback from Marina Promenade</p> <p>E= Match Existing Setback from River (Minimum)</p> <p>F= Southernmost Point of Portion Permitted Closer to River to Align with Straight Portion of Marina Promenade</p> <p>G= Northernmost Point of Portion Permitted Closer to River to Align with Straight Portion of Setback from Marina Promenade</p> <p> Addition Permitted to be Removed</p> <p style="text-align: center;"><u>KEY TO TERMINAL BUILDING</u></p>
	Building Type 'B' Permitted		
	Building Type 'A' or 'B' Permitted		
	Building Type 'B' or 'C' Permitted		
	Building Type 'D' Permitted		
	Terminal Building Parcel		
	Required Civic Square		
			
<p>X = 2' at Lake Avenue 2' at Corrigan Street 2' at Portside Drive 2' at North River Street South of Portside Drive 5' at North River Street North of Portside Drive</p> <p style="text-align: center;"><u>LOCATION OF REQUIRED BUILD-TO-LINE (RBL) AND PARKING SETBACK AT PARCELS I & II</u></p>			

KEY TO REGULATING PLAN

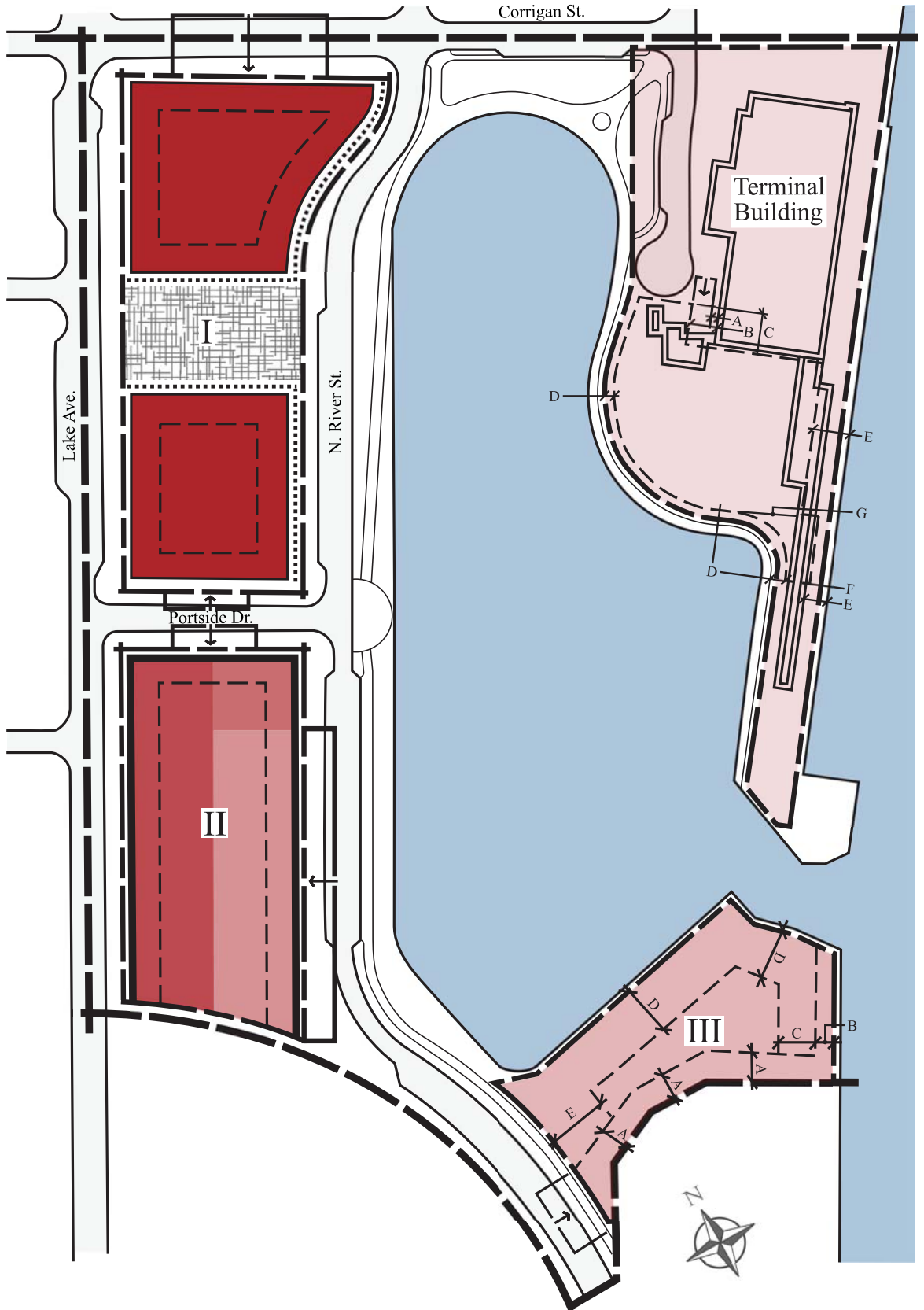

B

Building Envelope Standards

M-D Marina District

This page intentionally left blank.

B. Building Envelope Standards

Intent. The primary intent of the BUILDING ENVELOPE STANDARDS is to define and shape street and civic spaces in order to create a vital and coherent public realm. The interface of private building frontages with public thoroughfares and civic spaces shapes the public realm and is the principle focus of the BUILDING ENVELOPE STANDARDS.

(1) General Provisions

The following provisions are applicable to the BUILDING ENVELOPE STANDARDS for each Frontage Type and Building Type unless otherwise indicated within the standards for each Type.

(a) Adjacencies

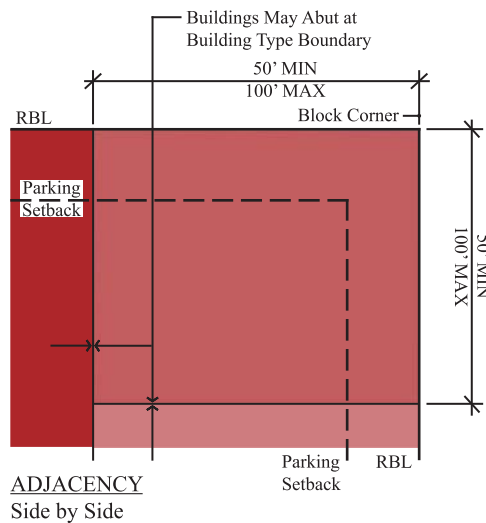

[1] Side by Side: Where the REGULATING PLAN indicates abutting Building Types and the boundary line is perpendicular to the REQUIRED BUILD-TO LINE (RBL), the boundary between each Building Type may be located between 50 feet and 100 feet from the BLOCK CORNER. No side yard is required and buildings may abut each other with no break in the continuity of the building FAÇADES;

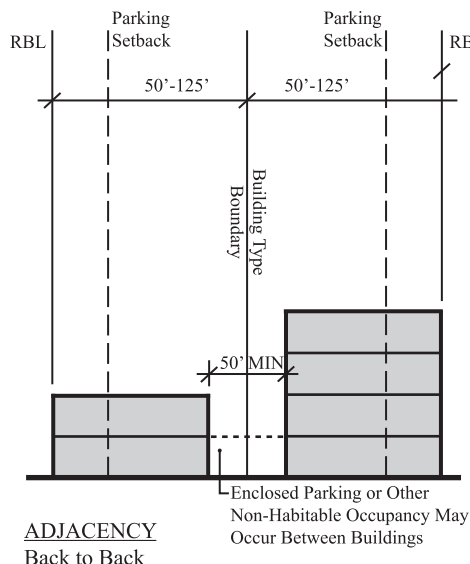

[2] Back to Back: Where the REGULATING PLAN indicates abutting Building Types and the boundary line is parallel to and does not intersect with the RBL, the boundary between each Building Type may be located between 50 and 125 feet from the RBL on either side. Rear yards shall be provided on either or both sides of the Building Type boundary such that the minimum distance between rear building walls is 50 feet. This requirement is not applicable where there is structured parking or other non-habitable space located behind the PARKING SETBACK LINE, but is applicable to portions of the building located above such a structure.

(b) Height Measurement

[1] The height of all buildings is measured in stories unless otherwise indicated in the BUILDING ENVELOPE STANDARDS for each building type;

[2] An ATTIC STORY is not included in the height measurement and may be added to the maximum height of a building;

[3] Mezzanines with an area greater than 1/3rd of the floor area of the story in which they are located shall be counted as a full story in the height measurement.

(c) Siting

(Provisions of this section are applicable to PARCELS I and II only. See §120-77.2B(3)(d) and §120-77.2B(3)(e) for the siting requirements for PARCEL III and the Terminal Building.)

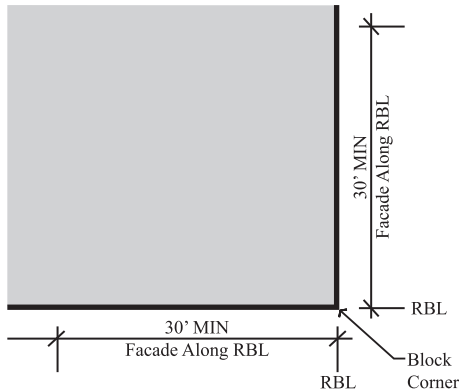

BLOCK CORNER

[1] The building FAÇADE shall be built to the REQUIRED BUILD-TO LINE (RBL) within 30 feet of a BLOCK CORNER or a chamfered or rounded corner.

[2] Blank lengths of wall exceeding 20 linear feet are prohibited on all RBL's;

[3] A STREET WALL not less than 6 feet nor more than 12 feet in height shall be required along any RBL that is not occupied by a building FAÇADE. The STREET WALL shall be located no more than 24 inches behind the RBL;

[4] The PARKING SETBACK LINE is located 30 feet behind the RBL and extends vertically as a plane. In permanent parking facilities, vehicle parking shall be located behind the PARKING SETBACK LINE except where provided completely below grade;

[5] Corner lots and through lots shall comply with the RBL requirements for their full frontages on all streets and the required CIVIC SQUARE unless otherwise specified.

(d) Exceptions to the Required Build-To Line (RBL)

(Provisions of this section are applicable to PARCELS I and II only. See §120-77.2B(3)(d) and §120-77.2B(3)(e) for comparable requirements for PARCEL III and the Terminal Building.)

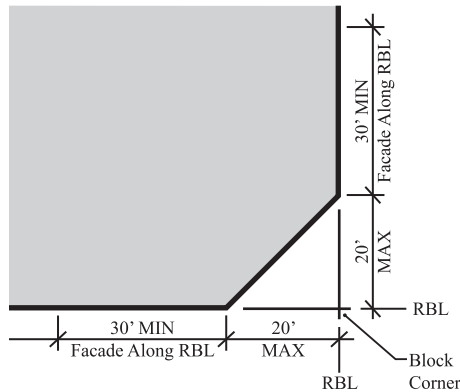

CHAMFERED CORNER

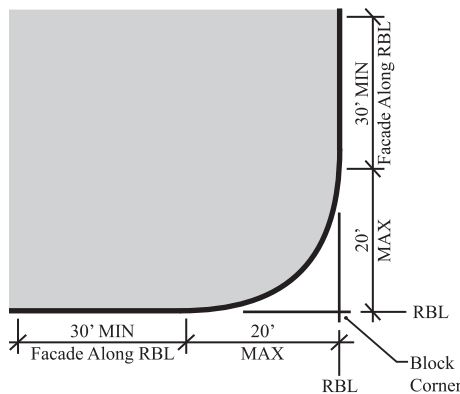

ROUNDED CORNER

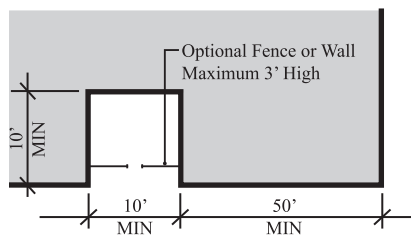

FORECOURT

[1] The building FAÇADE may include variations that project or recess from the RBL up to 24 inches;

[2] Storefront assemblies (doors, display windows, bulkheads and associated framing) may be recessed behind or project beyond the RBL by up to 24 inches and storefront entrances may be recessed from the storefront assembly;

[3] Within 20 feet of the BLOCK CORNER, the GROUND STORY FAÇADE may be chamfered to form a corner entry;

[4] Within 20 feet of the BLOCK CORNER, the GROUND STORY FAÇADE may be curved to form a rounded corner;

[5] Entry forecourts may be created by recessing the FAÇADE for a portion of the RBL. A forecourt shall be at least 10' by 10'. A fence or wall no higher than three feet, with a pedestrian opening, may be provided to define the space of the court. Only one forecourt per PARCEL is permitted to front on any street or the required CIVIC SQUARE except in Parcel I, one forecourt per street or CIVIC SQUARE is permitted north of the CIVIC SQUARE and south of the CIVIC SQUARE. Forecourts shall be located at least 50 feet from the BLOCK CORNER or a chamfered or rounded corner;

[6] Upper stories may be set back from the RBL. Except where there are porches and/or BALCONIES at the BLOCK CORNER, upper story setbacks shall be located at least 50 feet from the BLOCK CORNER or chamfered or rounded corner;

[7] Ground stories along non-commercial frontages may be set back from the RBL as needed to accommodate porches and/or stoops;

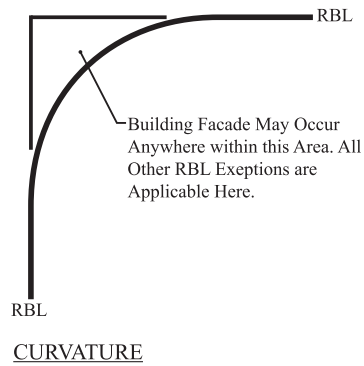

[8] Where the RBL follows the curvature of a street, the building FAÇADE may be located anywhere within the area formed by straight extensions of the RBL from each end of the curve. All other exceptions to the RBL may be utilized in this portion of the building FAÇADE;

[9] Projecting FAÇADE elements in compliance with §120-77.2F(3).

(2) Frontage Types

The Frontage Types describe the GROUND STORY condition and may be paired with any Building Type. Either Frontage Type may be located anywhere within the Marina District except that only the Commercial Frontage Type is permitted where mandatory Commercial Frontage is designated on the REGULATING PLAN.

(a) Commercial

Commercial Frontages are specifically designed to be suitable for retail, restaurant, service and similar uses that encourage a substantial amount of pedestrian interaction with the public thoroughfare. They are characterized by substantial storefront windows with closely spaced entrances from the street. They may have projecting FAÇADE elements over the sidewalk such as awnings, canopies or GALLERIES.

[1] GROUND STORY Floor Elevation:

Maximum 18 inches above the average sidewalk elevation at the REQUIRED BUILD-TO LINE (RBL) or the REQUIRED FRONTAGE ZONE (RFZ); where sidewalks are sloped, elevation may exceed 18 inches but may not exceed 3 feet above the sidewalk;

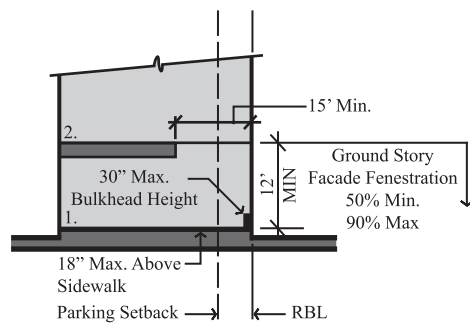

COMMERCIAL FRONTAGE

[2] Minimum GROUND STORY Height:

12 feet clear (floor to ceiling) contiguous to the RBL or RFZ frontage for a minimum depth of 15 feet;

[3] FENESTRATION:

The primary GROUND STORY FAÇADE shall have areas of transparency equal to at least 50% but no more than 90% of the FAÇADE area of the GROUND STORY. Storefront bulkheads shall have a maximum height of 30 inches above finished floor;

[4] Maximum Distance between Entrances:

Doors or entrances with public access to ground story spaces shall be provided at intervals of not less than 75 feet. Entrances shall remain unlocked and available for public use during regular business hours;

[5] Sidewalk:

The space between the public right-of-way boundary and the RBL shall be paved so as to become an extension of the public sidewalk. Paving materials shall match or complement the sidewalk. Asphalt and gravel paving are not permitted;

[6] Use:

Residential uses, including lodging, are not permitted on the GROUND STORY except for lobbies and associated common spaces.

(b) Non-Commercial

Non-Commercial Frontages are suitable for residential, lodging, office and other uses that do not depend on a substantial amount of pedestrian interaction with the public thoroughfare. They are characterized by smaller windows and are elevated above the sidewalk level in order to reduce views into the interior spaces from the sidewalk. Entrances may be spaced farther apart.

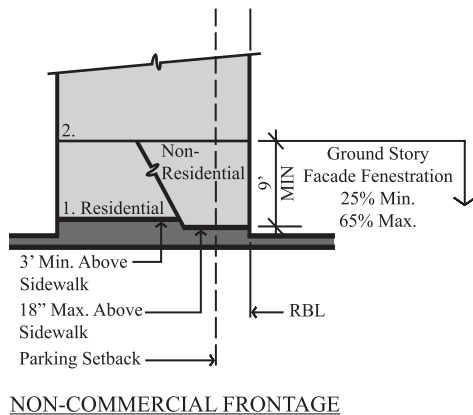

[1] GROUND STORY Floor Elevation (where there are residential uses, including lodging):

Minimum 3 feet above the average sidewalk elevation at the REQUIRED BUILD-TO LINE (RBL) or the REQUIRED FRONTAGE ZONE (RFZ); where sidewalks are sloped elevation may be minimum 2 feet and maximum 6 feet above the sidewalk;

[2] GROUND STORY Floor Elevation (where there are non-residential uses):

Maximum 18 inches above the average sidewalk elevation at the RBL or RFZ; where sidewalks are sloped, elevation may exceed 18 inches but may not exceed 3 feet above the sidewalk;

[3] Minimum GROUND STORY Height:

The GROUND STORY shall have at least 9 feet of clear interior height (floor to ceiling);

[4] FENESTRATION:

The primary GROUND STORY FAÇADE shall have areas of transparency equal to at least 25% but no more than 50% of the total FAÇADE area of the GROUND STORY, with each FAÇADE area calculated independently;

[5] Sidewalk:

The space between the public right-of-way boundary and the RBL may be paved so as to become an extension of the public sidewalk or may be landscaped so as to become a buffer between the building and the street. Paving materials shall match or complement the sidewalk. Asphalt and gravel paving are not permitted;

[6] Use:

Although this frontage type is best suited to residential or low intensity non-commercial uses, any use allowed within the Marina District is permitted.

(3) Building Types

The REGULATING PLAN indicates permitted locations for each Building Type. For each Building Type there is a set of BUILDING ENVELOPE STANDARDS that are intended to achieve the desired built form and pedestrian orientation of the Marina District.

(a) Type A, Low Rise Block



This Building Type is limited in height in order to preserve views of the harbor from the Lighthouse Trail and views of the lighthouse from the marina area. This Building Type may include attached single-family dwellings (townhouses) or other small scale buildings and may have commercial or non-commercial frontages. This Building Type is permitted on PARCEL II.

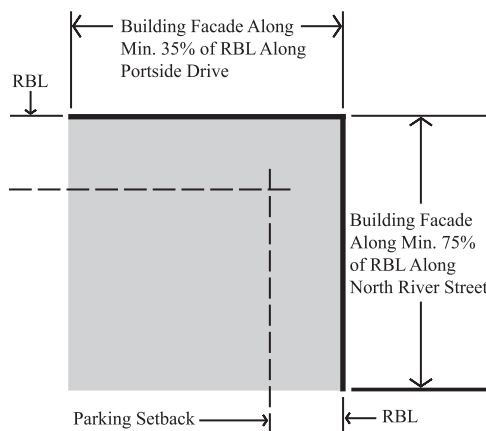

BUILDING TYPE 'A' - SITING

[1] Siting:

Building FAÇADES fronting on Corrigan Street shall be built to the REQUIRED BUILD-TO LINE (RBL) for at least 35% of the RBL length along that block. Building FAÇADES fronting on North River Street shall be built to the RBL for at least 75% of the RBL length along that block. Exceptions to the RBL in compliance with §120-77.2B(1)(d) are included within the minimum FAÇADE length;

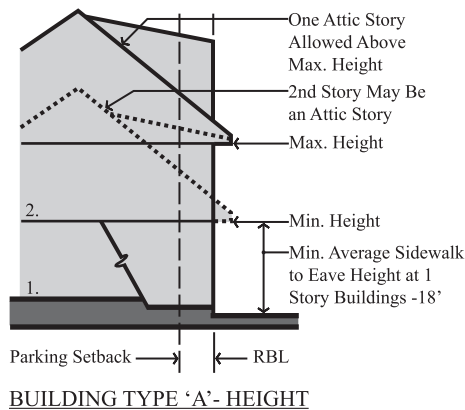

BUILDING TYPE 'A'- HEIGHT

[2] Building Height:

Minimum one story, 18 feet from average sidewalk elevation to eave, or top of cornice or parapet;
 Maximum 2 stories, 1 additional story is permitted within the northernmost 50% of the area designated on the REGULATING PLAN for this building type;

[3] Upper Story FENESTRATION:

Primary FAÇADES and FAÇADES visible from any street or open space shall have areas of transparency equal to at least 25% but no more than 50% of the total FAÇADE area, with each FAÇADE area calculated independently;

[4] Use:

Non-residential uses are prohibited above residential uses.

(b) Type B, Mid-Rise Block



The Mid-Rise Block is the basic background building that forms most of the fabric in neighborhood, town and village centers across the United States. The primary form is that of a two or more story building placed directly adjacent to or in very close proximity to the sidewalk. Mid-Rise Block buildings may or may not have commercial frontage on the GROUND STORY. Mid-Rise Block buildings typically house a wide range of uses and can be adapted to change their functions over time. Such buildings may be devoted to a single use or may have multiple uses. This range of uses will contribute to the vitality that is desired for the Marina District. This Building Type is permitted on PARCELS I and II.



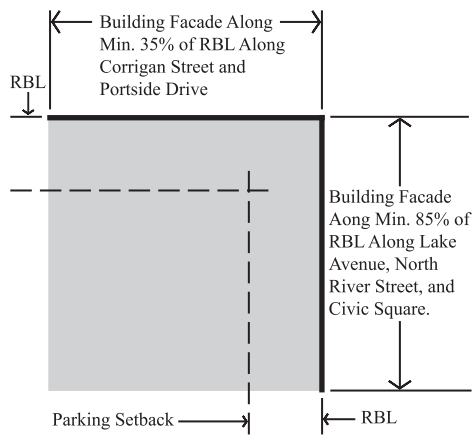

BUILDING TYPE 'B' - SITING

[1] Siting:

Building FAÇADES fronting on Portside Drive and Corrigan Street shall be built to the REQUIRED BUILD-TO LINE (RBL) for at least 35% of the RBL length along those blocks. Building FAÇADES fronting on Lake Avenue, North River Street and the required CIVIC SQUARE shall be built to the RBL for at least 85% of the RBL length along those blocks. Exceptions to the RBL in compliance with §120-77.2B(1)(d) are included within the minimum FAÇADE length;

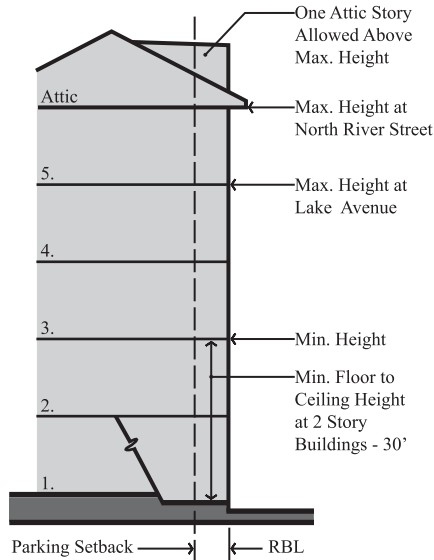

BUILDING TYPE 'B' - HEIGHT

[2] Building Height:

Minimum 2 stories;
 2 story buildings shall have a minimum clear height from the GROUND STORY floor to the 2nd story ceiling of 30 feet;
 Maximum 4 stories at Lake Avenue, 5 stories at North River Street; Up to two additional stories permitted at BLOCK CORNERS or center of building mass up to 25% of building footprint;

[3] Upper Story FENESTRATION:

Primary FAÇADES and FAÇADES visible from any street or open space shall have areas of transparency equal to at least 25% but no more than 50% of the total FAÇADE area, with each FAÇADE area calculated independently;

[4] Use:

Non-residential uses are prohibited above residential uses except that recreational facilities associated with the residential use may be located on the uppermost story.

(c) Type C, Tower Block



This Building Type allows taller buildings to be constructed above a ‘podium’ or base. The podium is similar to the Mid-Rise Block, with the same relation to the street. The tower above is required to be stepped back from the FAÇADE of the podium to maintain the scale of the buildings along the REQUIRED BUILD-TO LINE (RBL), increase the amount of sunlight reaching the sidewalk and minimize the apparent bulk of the tower from the street. This Building Type is permitted on PARCEL I.

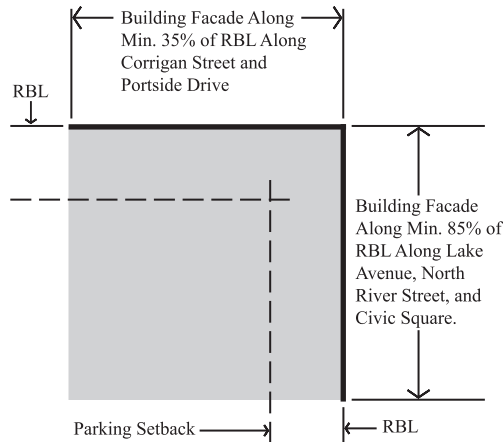

BUILDING TYPE ‘C’- SITING

[1] Podium Siting:

Podium FAÇADES fronting on Portside Drive and Corrigan Street shall be built to the RBL for at least 35% of the RBL length along those blocks. Podium FAÇADES fronting on Lake Avenue, North River Street and the required CIVIC SQUARE shall be built to the RBL for at least 85% of the RBL length along those blocks. Exceptions to the RBL in compliance with §120-77.2B(1)(d) are included within the minimum FAÇADE length;

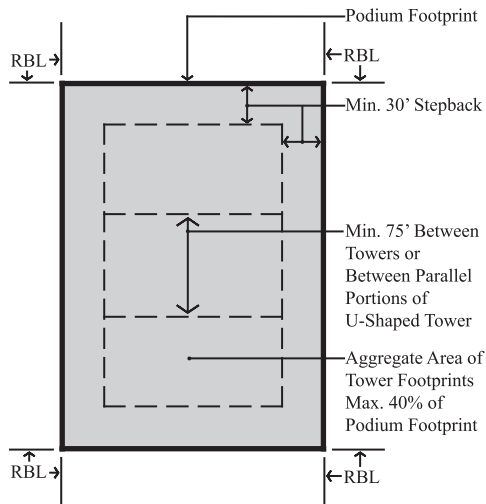

BUILDING TYPE 'C' - TOWER SITING

[2] Tower Siting:

One or more towers may be constructed above a podium provided they comply with the following:

[a] Towers shall be stepped back at least 30 feet from the RBL above the maximum height of the podium;

[b] Tower FAÇADES shall be substantially parallel to the RBL;

[c] The aggregate building footprint of the towers above the maximum height of the podium shall not exceed 40% of the building footprint of the podium;

[d] Where there is more than one tower or where there is a U shaped tower building footprint, the minimum distance between parallel building walls shall be 75 feet;

[e] The top two stories (not including stories contained within a pitched roof) shall employ step-backs, roof forms such as spires, cupolas or belvederes or other configurations or techniques to create a distinctive roof profile.

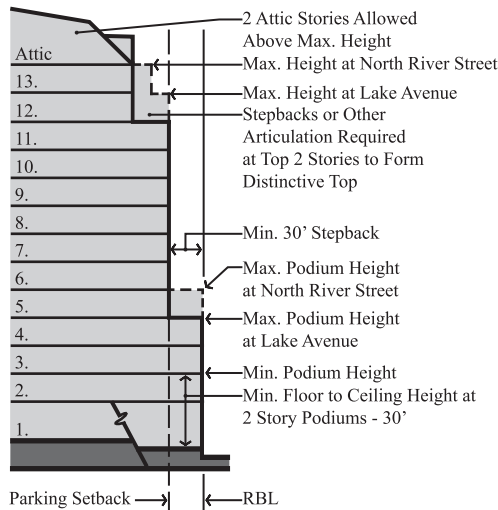

BUILDING TYPE 'C' - HEIGHT

[3] Building Height:

[a] Podium:

Minimum 2 stories;

2 story podiums shall have a minimum clear height from the GROUND STORY floor to the 2nd story ceiling of 30 feet;

Maximum 4 stories at Lake Avenue, 5 stories at North River Street;

[b] Overall Building Height:

Maximum 12 stories at Lake Avenue, 13 stories at North River Street; Up to two additional ATTIC STORIES permitted in a tower if contained within a single pitched roof with DORMERS;

[4] Upper Story FENESTRATION:

Primary FAÇADES and FAÇADES visible from any street or open space shall have areas of transparency equal to at least 25% but no more than 50% of the total FAÇADE area, with each FAÇADE area calculated independently;

[5] Use:

Non-residential uses are prohibited above residential uses except that recreational facilities associated with the residential use and/or restaurants may be located on the top two stories, the uppermost story or the first story above the podium and may utilize outdoor space above the podium. Bars, cocktail lounges and taverns as defined in §120-208 and nightclubs as defined in Section 202 of the Existing Building Code of New York State are prohibited from these locations.

(d) Type D, Edgeyard Building

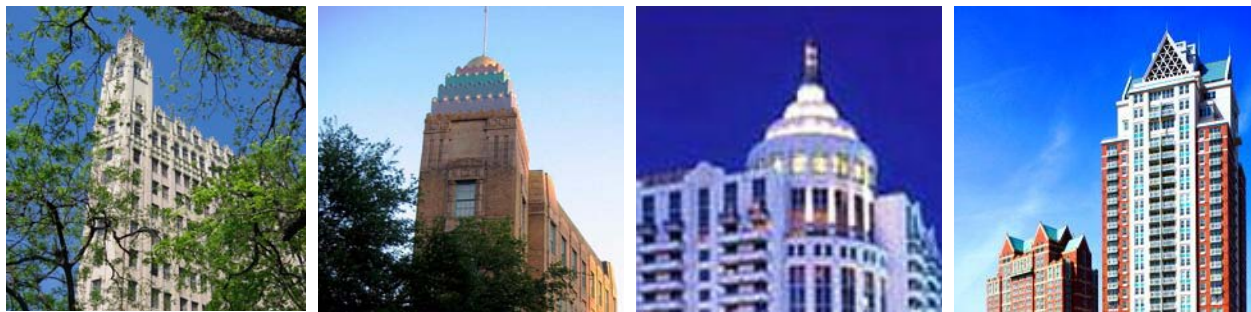

This Building Type is suited for those sites where it is less critical to the public realm that buildings be placed adjacent or close to the sidewalk. In this building type, a REQUIRED FRONTAGE ZONE (RFZ) is substituted for the REQUIRED BUILD-TO LINE (RBL). This allows greater flexibility in determining the building footprint and allows for the possibility of front and side yards. This Building Type is permitted on PARCEL III.

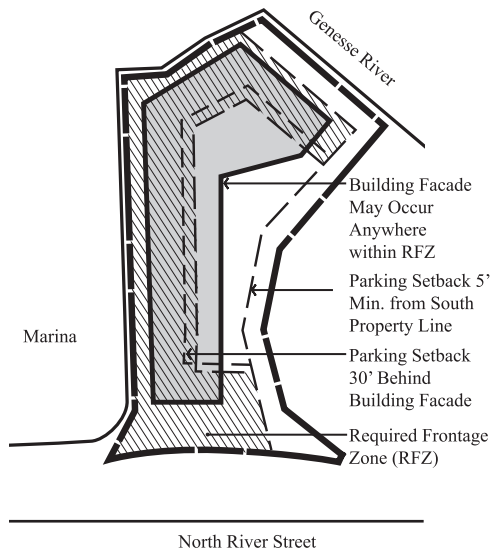

BUILDING TYPE 'D' - SITING

[1] Siting:

The building FAÇADE of the first 2 stories shall occur entirely within the REQUIRED FRONTAGE ZONE (RFZ) indicated on the REGULATING PLAN with the following exceptions permitted:

The building FAÇADE may include variations that recess behind the inside boundary or project beyond the outside boundary of the RFZ up to 24 inches;

Storefront assemblies (doors, display windows, bulkheads and associated framing) may be recessed behind the inside boundary of the RFZ or project beyond the outside boundary of the RFZ by up to 24 inches and storefront entrances may be recessed from the storefront assembly; Projecting FAÇADE elements in compliance with §120-7702E(3) may project beyond the outside boundary of the RFZ;

[2] PARKING SETBACK LINE:

The PARKING SETBACK LINE shall be located 30 feet behind the building FAÇADE wall, except at the south property line, parking facilities shall be set back at least 5 feet;

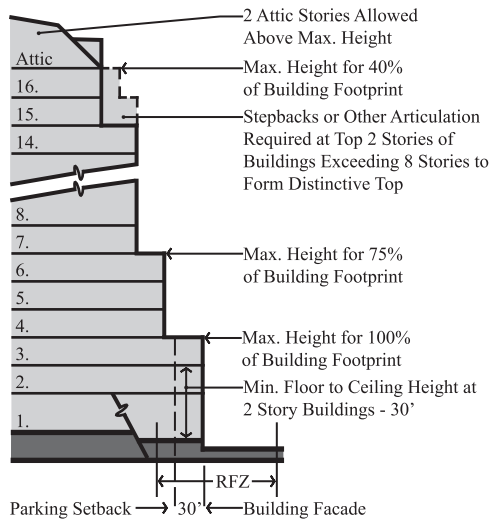

BUILDING TYPE 'D' - HEIGHT

[3] Building Height:

Minimum 2 stories;

2 story buildings shall have a minimum clear height from the GROUND STORY floor to the 2nd story ceiling of 30 feet;

Maximum 3 stories for primary building;

75% of building footprint may be up to 3 additional stories provided this portion of the building occurs within the 85% of the building footprint closest to the Genesee River;

40% of building footprint may be up to 16 stories provided this portion of the building occurs within the 50% of the building footprint closest to the Genesee River. Where the building is 8 to 16 stories, up to two additional ATTIC STORIES are permitted if contained within a single pitched roof with DORMERS. Where the building exceeds 8 stories in height, the top two stories (not including stories contained within a pitched roof) shall employ step-backs, roof forms such as spires, cupolas or belvederes or other configurations or techniques to create a distinctive roof profile.

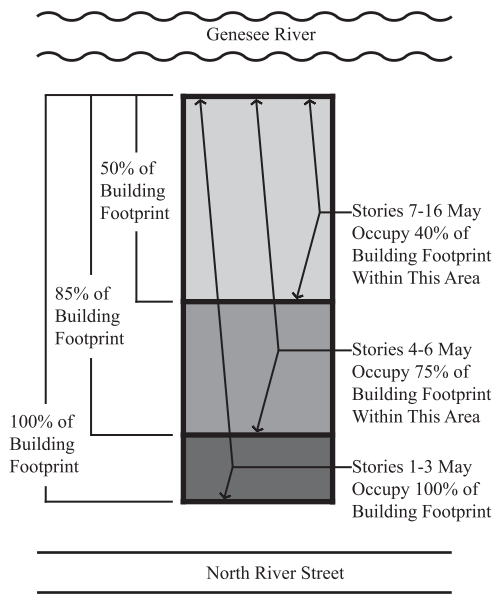

BUILDING TYPE 'D' - HEIGHT

[4] Upper Story FENESTRATION:

Primary FAÇADES and FAÇADES visible from any street or open space shall have areas of transparency equal to at least 25% but no more than 50% of the total FAÇADE area, with each FAÇADE area calculated independently;

[5] Use:

Non-residential uses are prohibited above residential uses except in buildings exceeding 3 stories in height, recreational facilities associated with the residential use may be located on the uppermost story and in buildings exceeding 8 stories in height, recreational facilities associated with the residential use and/or restaurants may be located on the top two stories or the uppermost story. Bars, cocktail lounges and taverns as defined in §120-208 and nightclubs as defined in Section 202 of the Existing Building Code of New York State are prohibited from these locations.

(e) Existing Buildings

The Terminal Building is the only existing building of significance within the Marina District. This section governs demolition, exterior alterations and additions to this structure.

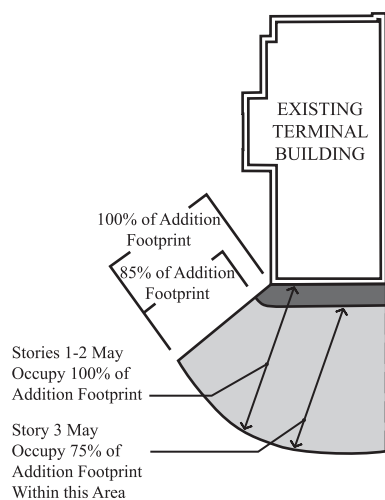

TERMINAL BUILDING ADDITION-HEIGHT

[1] Demolition:

Demolition of any portion of the Terminal Building except additions south of the original south building wall shall be prohibited;

[2] Exterior Alterations:

Significant architectural features including but not limited to original exterior wall finishes, the second story open veranda, the clock tower, decorative cornices, windows, doors, trim around openings, railings, storefronts and any significant decorative features shall be maintained;

[3] Addition Siting:

An addition may be constructed within the area indicated on the REGULATING PLAN. The building FAÇADE of the first 2 stories shall occur entirely within the REQUIRED FRONTAGE ZONE (RFZ) indicated on the REGULATING PLAN with the following exceptions permitted:

The building FAÇADE may include variations that project beyond the outside boundary of the RFZ up to 24 inches; Storefront assemblies (doors, display windows, bulkheads and associated framing) may project beyond the outside boundary of the RFZ by up to 24 inches;

Awnings, canopies and GALLERIES may project beyond the outside boundary of the RFZ;

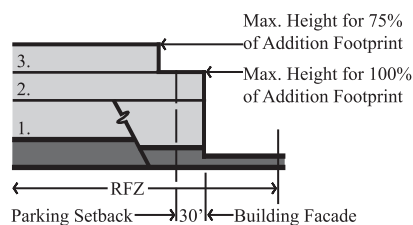

TERMINAL BUILDING ADDITION-HEIGHT

[4] Addition PARKING SETBACK LINE:

The PARKING SETBACK LINE shall be located 30 feet behind the building FAÇADE wall of any addition;

[5] Addition Height:

Maximum 2 stories for primary addition, 75% of building footprint may be up to 1 additional story provided this portion of the building occurs within the 85% of the building footprint farthest from the existing Terminal Building;

[6] Upper Story FENESTRATION:

Primary FAÇADES and FAÇADES visible from any street or open space shall have areas of transparency equal to at least 25% but no more than 50% of the total FAÇADE area, with each FAÇADE area calculated independently;

[7] The Architectural Standards in §120-77.2F are not applicable to the Terminal Building. The Director of Planning and Zoning shall refer all proposed exterior alterations and/or additions to the Project Review Committee for recommendations and shall approve or disapprove the proposals based on those recommendations.

C

Building Function (Use)

M-D Marina District

This page intentionally left blank.

C. Building Function (Use)

Intent. This Section establishes permitted, specially permitted and prohibited uses within the Marina District. In order to maximize the liveliness, vitality and pedestrian character of the district, most uses are permitted as of right. Uses that are detrimental to the pedestrian character of the district are generally prohibited. The BUILDING ENVELOPE STANDARDS contain additional requirements pertaining to mixed uses within buildings.

(1) Permitted Uses

All uses are permitted in fully enclosed buildings in the Marina District unless listed as specially permitted or prohibited uses in this article. In addition to any specific requirements listed below, uses shall be subject to the additional requirements for the specified uses set forth in Article XVIII of this chapter.

(2) Permitted Outdoor Uses



- (a) Accessory outdoor seating areas without background music or entertainment;
- (b) Accessory display of merchandise during business hours;
- (c) Food vending carts and trucks may be located in interim parking facilities constructed in accordance with §120-77.2E(3), in the required CIVIC SQUARE and on the grounds of the Terminal Building;
- (d) Farmer markets may be located in interim parking facilities constructed in accordance with §120-77.2E(3), in the required CIVIC SQUARE and on the grounds of the Terminal Building;
- (e) Walk-up service windows;
- (f) Permanent parking constructed in accordance with §120-77.2E(1).

(3) Specially Permitted Uses

The following uses are allowed as special permit uses in the Marina District:

- (a) Outdoor entertainment;
- (b) Interim Parking constructed in conformance with §120-77.2E(2) and §120-173F. Special permits for Interim Parking shall be subject to renewal every five years. Each renewal application shall be subject to a marketability analysis demonstrating that the site cannot be developed based on the following standards:

[1] The site is not marketable for development in accordance with the intent of the Marina District as demonstrated by at least one of the following factors:

- [a] The inability to find an interested developer or buyer over an extended period of time;
- [b] Physical location or locational limitations or deficiencies or the site or public infrastructure.

[2] Standards indicating the type of information required to document conformance with each of the aforementioned standards shall be as adopted from time to time by the Planning Commission.

(4) Prohibited Uses

The following uses are prohibited in the Marina District:

- (a) Homeless shelters;
- (b) Sexually oriented businesses;
- (c) Uses not in a fully enclosed building or not permitted by §120-77.2C(2);
- (d) Any use that would meet the definition of a manufacturing use as per §120-208 of the Zoning Code;
- (e) Drive-throughs;

(f) Vehicle - related uses, including car washes, vehicle service stations, vehicle sales, vehicle repair including commercial vehicle repair and vehicle rental services, except vehicle rental or sharing services in which vehicles are stored in permanent parking facilities constructed in accordance with §120-77.2E(1), vehicle service takes place outside the Marina District and offices are located in a fully enclosed building;

(g) Funeral homes;

(h) Places of worship;

(i) Warehouses;

(j) Recycling centers.

This page intentionally left blank.

D

Civic Square Standards

M-D Marina District

This page intentionally left blank.

D. Civic Square Standards



Intent. These standards are applicable to the required CIVIC SQUARE indicated on the REGULATING PLAN on PARCEL I. The square will be the principle pedestrian connection between Lake Avenue and River Street and the marina. It will be an active pedestrian center and a major focal point within the Marina District. In order to facilitate pedestrian activity, most of the square will have paved surfaces. The use of pervious paving materials to allow oxygen for tree roots and to absorb storm water run-off is encouraged.



(1) Location and Dimensions

The CIVIC SQUARE shall extend from the Lake Avenue public right-of-way to the River Street public right-of-way as shown on the REGULATING PLAN subject to the following requirements:

- (a) Minimum 150 feet south of the REQUIRED BUILD-TO LINE (RBL) fronting on Corrigan Street and 150 feet north of the RBL fronting on Portside Drive;
- (b) Width: 85 feet minimum, 150 feet maximum. The width of the square may vary within these parameters.

(2) Pavements

At least 65% of the surface area of the CIVIC SQUARE shall be paved. Any type of unit pavers or concrete pavement, excluding stamped concrete, is permitted. Asphalt paving, excluding hexagonal asphalt pavers, is prohibited.

(3) Trees

The use of trees to shade portions of the CIVIC SQUARE is encouraged. Trees shall be of deciduous species.

(4) Clear Views

To maximize views, and to ensure public safety, there shall be a clear view zone between two and eight feet above grade. Tree trunks, street lights, kiosks, fountains, public art or monuments are permitted to be within the clear view zone. The foliage of newly planted trees may be within the clear view zone until the tree has sufficient growth to allow the removal of branches below eight feet.

(5) Slope

The CIVIC SQUARE shall be designed in compliance with the most current ADA Standards for Accessible Design.

E

Parking & Loading Standards
M-D Marina District

This page intentionally left blank.

E. Parking & Loading Standards

Intent. This Section establishes standards for the placement of and access to permanent vehicular parking facilities associated with buildings and interim vehicular parking that may be located on PARCELS I, II and III until those PARCELS are developed. It also establishes standards for short and long term bicycle parking and loading areas.

(1) Permanent Parking Facilities

- (a) All parking provided for users of a particular building shall be provided on the site of that building.
- (b) Permanent parking facilities, except for those that are completely below grade, shall be located no closer to the public right-of-way than the Required PARKING SETBACK LINE indicated on the REGULATING PLAN.
- (c) A maximum of one ingress and one egress lane to permanent parking facilities are permitted within each allowable area designated on the REGULATING PLAN. Ingress/Egress driveways shall be located at least 50 feet from BLOCK CORNERS. Combined In/Out driveways shall have a maximum width of 22 feet. Separate In and Out driveways shall have a maximum width of 11 feet each.
- (d) Openings in any Building FAÇADE for parking garage entries shall have a maximum clear height no greater than 12 feet and a clear width no greater than 12 feet for single width openings or 24 feet for double width openings;
- (e) The height of parking structures shall not exceed the height of adjacent liner buildings constructed between the parking facility and the REQUIRED BUILD-TO LINE. There is no minimum height for parking structures.
- (f) Permanent parking facilities are not required to comply with §120-173F.
- (g) A minimum of 15% of parking spaces provided for building residents shall be provided with facilities capable of recharging the batteries of electric and plug-in hybrid vehicles. All parking spaces provided for residents shall be capable of having recharging facilities added in the future.

(2) Interim Parking Facilities

- (a) Paved parking facilities may be specially permitted to be temporarily located on undeveloped portions of PARCELS I, II and III until such time as these PARCELS are developed. Interim parking facilities shall be constructed in accordance with this section and with §120-173F. Such parking facilities shall be available for public use.

(b) Interim parking facilities shall be set back at least 15 feet from the public right-of-way.

(c) Ingress and egress to interim parking facilities shall be located within the allowable areas designated on the REGULATING PLAN where possible. Where the allowable access areas are not available, ingress and egress locations shall be approved by the Director of Planning and Zoning. Combined In/Out driveways shall have a maximum width of 22 feet. Separate In and Out driveways shall have a maximum width of 11 feet each.

(d) Parking areas shall be drained in accordance with §40-54B. This requirement may be waived if the parking area is paved with permeable pavements and/or if bio-swales, rain gardens or similar alternative drainage techniques are utilized, provided it is shown that these techniques will provide equivalent or better performance.

(e) The parking setback area shall be provided with minimal landscape treatment such as grasses or ground cover. Mulch is not an acceptable landscape treatment except when used to protect plantings. Trees are not required in the parking setback.

(3) Bicycle Parking

(a) The Marina District is located at the northern terminus of the Genesee River trail system. This location and the need to provide for and encourage non-motorized transportation make the provision of facilities for bicyclists a high priority. A significant amount of bicycle parking will be provided within public rights-of-way. This section sets forth minimum requirements for short term and long term bicycle parking on private development PARCELS.

(b) Short term bicycle parking shall be provided in the required CIVIC SQUARE and on the grounds of the Terminal Building. Short term bicycle parking may be provided in interim parking facilities constructed in accordance with §120-77.2E(3) and in other exterior locations in PARCELS I, II and III. Short term bicycle parking facilities shall comply with the following:

[1] Each bicycle parking space shall be accessible without moving another bicycle and its placement shall not result in a bicycle obstructing a required walkway;

[2] Bicycle racks may be installed in the public right-of-way subject to the approval of the Department of Environmental Services;

[3] Each bicycle parking space shall permit the locking of the bicycle frame and one wheel to the rack and shall support the bicycle in a stable position without damage to the wheels, frame or components;

[4] A minimum of 10 spaces shall be provided in the required CIVIC SQUARE;

[5] A minimum of 2 spaces plus 1 additional space for each 5000 square feet of retail space, 10,000 square feet of assembly space or 15,000 square feet of office space shall be provided on the Terminal Building grounds.

(c) Long term bicycle parking facilities for residents in buildings with residential dwelling units shall be provided in compliance with the following:

[1] Facilities shall be enclosed, secure and protected from the weather;

[2] Facilities shall be located on the GROUND STORY, between the REQUIRED BUILD-TO LINE (RBL) or REQUIRED FRONTAGE ZONE (RFZ) and the PARKING SETBACK LINE or behind the PARKING SETBACK LINE, and have direct access to a public right-of-way;

[3] Facilities shall be internally connected to the residential dwelling units;

[4] Each bicycle parking space shall be accessible without moving another bicycle and its placement shall not result in a bicycle obstructing a required walkway;

[5] Each bicycle parking space shall permit the locking of the bicycle frame and one wheel to the rack and shall support the bicycle in a stable position without damage to the wheels, frame or components;

[6] A minimum of 1 space for every 5 bedrooms shall be provided.

(4) Loading Facilities

(a) Access to loading areas, including dumpsters, shall be located within the allowable areas designated on the REGULATING PLAN. Except when located within a fully enclosed building, loading docks and dumpsters shall be located no closer to the public right-of-way than the Required PARKING SETBACK LINE indicated on the REGULATING PLAN. All loading docks and dumpsters shall be set back a sufficient distance from the public right-of-way to allow service vehicles to park entirely behind the REQUIRED BUILD-TO LINE.

(b) Driveways shall have a maximum width of 12 feet.

This page intentionally left blank.

F

Architectural Standards

M-D Marina District

This page intentionally left blank.

F. Architectural Standards and Guidelines

Intent. This Section establishes standards and guidelines for new construction within the Marina District to ensure that new development establishes a minimum level of architectural quality and positively contributes to the public realm. No particular architectural style is mandated or prohibited; rather the Architectural Standards and Guidelines are intended to promote harmony and help the district coalesce into a unified place. This section includes both mandatory standards and advisory guidelines. The advisory guidelines are intended to provide insight into some of the desired characteristics of the district, while the standards set the minimum requirements for architectural quality. The mandatory standards are applicable to building elements that are clearly visible from the street or any civic space. This includes all public streets and civic spaces within the Marina District and adjoining the Marina District, but does not include parking areas located in accordance with §120-77.2E. *Advisory guidelines are printed in italics.* Mandatory standards are printed in normal font. The Architectural Standards and Guidelines are organized as follows:

1. Context and Architectural Character
2. Composition and Articulation
3. Building FAÇADE Walls
4. Wall Openings
5. Roofs
6. Projecting FAÇADE Elements
7. Signage

(1) Context and Architectural Character



Where there is little context to relate to, the proper response is to create a new and worthy context. To achieve this goal, new buildings should establish an architectural character and pattern from which future development can take its cues. The creation of a unified, harmonious district is more important than the individual building. To this end, an “architecture of place” is preferred over an “architecture of our time.” Charlotte’s past as a resort community included fantastical amusement park structures and hotels, which helped make Charlotte a distinctive and memorable place. Charlotte’s lost historic buildings are part of a living tradition, which included buildings that spanned the vernacular to classical spectrum, from simple wood frame structures to elaborate masonry and stucco buildings rendered in exotic architectural styles. The standards and guidelines that follow are largely based upon principles that underlie this living tradition. The intent is not to replicate historic buildings, but to encourage a range of architectural expressions that will once again establish Charlotte and the Marina District as a distinctive and memorable place.



(2) Composition and Articulation

It is likely that most of the buildings in the Marina District will be constructed at a larger scale, both horizontally and vertically, than any previous buildings in Charlotte. Large structures can be monolithic, monotonous, and lacking in human scale. This can be avoided through principles of composition and proportion.

- *Each composition should be conceived as a whole assembled from composite parts, which in turn are wholes composed of smaller parts;*
- *Each building mass and FAÇADE composition should have a strong focus or center. The focus need not be at the geometric center of the composition and the composition need not be symmetrical;*
- *Each composition should have a readily definable base, middle and top and left, middle and right;*
- *Parts of the composition should be joined by transitional elements that both separate and link adjacent parts;*
- *Some elements of the composition should be dominant, while others are subordinate. This establishes a hierarchy, which is a defense against the monotony of simple repetition.*

(a) Horizontal Transitions

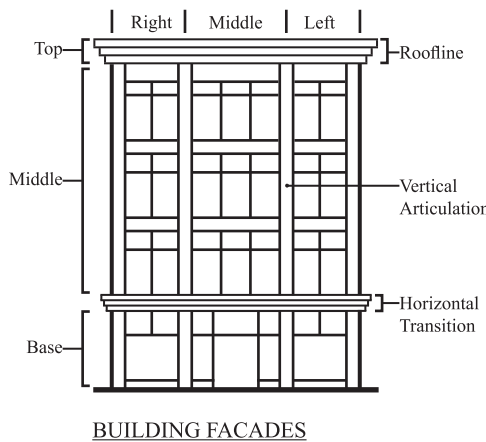

Building FAÇADES shall have Horizontal Transitions. A Horizontal Transition is an architectural element, such as a cornice, BALCONY, GALLERY or change in material that creates a distinction between the first and second stories or between the second and third stories. Horizontal Transitions are not required in buildings with Non-Commercial frontages.

(b) Roof Lines

Building FAÇADES shall have Roof Lines. A Roof Line is an architectural element, such as a cornice, parapet or change in material, which creates a distinction between the top of the building and the lower stories.

- *Horizontal transitions and roof lines are the means to achieve a distinctive horizontal base; occupied middle; and top that complement and balance one another.*

(c) Vertical Articulations

Building FAÇADES shall have Vertical Articulations. Vertical articulations can be produced by variations in roof lines; window groupings; applied FAÇADE elements such as piers or pilasters, BAY WINDOWS and BALCONIES; entrance stoops and porches; and subtle changes in materials and vertical planes that create shadow lines and textural differences.

- *Each building should have a clear and harmonious pattern of vertically-oriented FAÇADE elements that break up long monolithic walls and divide the composition into one or more segments, each with a discernible left, middle and right. A balance of vertical and horizontal lines should be sought, with the balance tipped slightly to the vertical;*
- *Changes in vertical planes should be part of a larger FAÇADE composition and should not be used to present a false image of individual buildings. Where separate buildings abut, the principle planes of the FAÇADES should be flush.*

(3) Building Façade Walls**(a) Finish Materials**

Each building FAÇADE may have two or more finish materials. STREET WALLS shall be constructed of a material matching the adjacent building FAÇADE.

- *Materials should be separated horizontally, with “lighter” materials placed above more substantial materials, for example wood above stucco or masonry, or stucco above masonry.*

(b) Projecting Elements

All elements that project from the building by more than 16 inches, such as BALCONIES, BAY WINDOWS, canopies and marquees shall be visibly supported from below or above by brackets, posts, columns, pilasters or similar supports that are sized proportionately to the projecting structure.

(c) Primary Materials

The following primary materials are permitted:

- [1] Masonry, including brick, stone, terra cotta, ceramic tile or similar facings;
- [2] Cementitious stucco with smooth or sand finish;
- [3] Fiber cement panels, siding and trim boards. Wood grain finishes are not permitted (Building Types ‘A’ and ‘B’ only);
- [4] Solid PVC paintable or prefinished siding and trim boards (such as NuCedar Mills or equivalent). Wood grain finishes are not permitted (Building Types ‘A’ and ‘B’ only);
- [5] Painted wood clapboards or painted, stained or natural shingles. (Buildings Types ‘A’ and ‘B’ only).

(d) Secondary Materials

The following secondary materials are permitted for up to 10% of a building wall surface:

- [1] Pre-cast masonry (for lintels, trim and cornices only);

[2] Exterior Insulation Finish System (EIFS) with smooth or sand finish. (EIFS may be utilized above the Horizontal Transition only);

[3] Metal (for beams, lintels, trim elements and ornamentation only);

[4] Polyurethane (such as Fypon or equivalent) Millwork (for lintels, trim elements and ornamentation only);

[5] Glazed, ground face or split face concrete block (used as accent trim, piers and foundation walls only);

[6] Glass block.

- *The palette of wall materials should be kept to a minimum, preferably two (e.g. stucco and tile, brick and stone) or less. Using the same wall materials as adjacent or nearby buildings helps strengthen the district character;*
- *Stucco and/or painted stucco surfaces should be smooth to prevent the collection of dirt and surface pollutants, and the deterioration of painted surfaces;*
- *Sheet metal parapet cap flashings should be painted to match wall or trim color;*
- *The following materials are not appropriate:*
 - *Curtain Wall systems except in limited areas such as connections; between buildings, entrance lobbies, etc;*
 - *Simulated finishes such as artificial stone;*
 - *Plywood siding.*

(4) Wall Openings**(a) Opening Proportions**

[1] Windows, doors and other openings (except at GROUND STORY commercial frontages) shall be square or vertical in proportion. Except at BAY WINDOWS, window frames shall be recessed at least 3 inches from the plane of masonry or stucco building FAÇADES;

[2] Windows may be ganged horizontally if each grouping is separated by a framing element at least seven inches wide.

- *The width to height ratio of windows, doors and similar elements should typically be 1:2 or 2:3.*

(b) Permitted Finish Materials:

[1] Windows and doors may be of steel; aluminum; including clear anodized or factory finished colors; fiberglass; aluminum clad wood; painted wood; stained or natural (clear finish) wood;

[2] Glazing shall be clear or lightly tinted;

[3] If muntins are provided, they shall be of the true divided or simulated divided (applied to interior and exterior with spacer bar within the glazing) types.

(5) Roofs**(a) Permitted Configuration**

[1] Flat, (pitched as required for drainage) concealed by a parapet no less than 42 inches high or as required to conceal mechanical equipment. The parapet may have pitched, stepped or curved forms that help create a roof line;

[2] Gabled, symmetrically sloped, with a minimum pitch of 5:12, with eaves and/or partially concealed by a parapet;

[3] Hipped, symmetrically sloped, with a minimum pitch of 5:12, with eaves and/or partially concealed by a parapet;

[4] Shed, with a minimum pitch of 2:12 where attached to a larger building mass, with eaves and/or partially concealed by a parapet;

[5] Barrel Vaulted;

[6] Domed

- *Roof forms should complement the building mass and match the principal building in terms of style, detailing and materials. Double-pitched roofs (such as gable, hip, pyramid), dormer windows, and chimneys can add variety and visual interest when viewed from the streets below and from a distance. Flat roofs are acceptable if a strong, attractively detailed cornice and/or parapet wall is provided. Single-pitched or “shed” roofs should not be used for the principal building. Where the BUILDING ENVELOPE STANDARDS require “a distinctive roof profile” (Building Types ‘C’ and ‘D’), additional roof forms may be considered.*

(b) Mansard Roofs

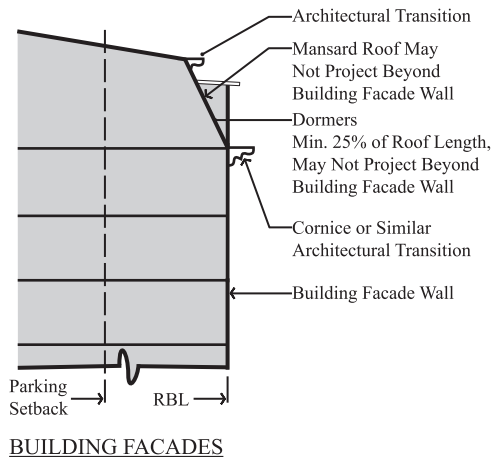

[1] Mansard roofs are a type of pitched roof that are considered ATTIC STORIES and therefore not counted against the maximum story height. Mansards may be added only to buildings that are at least two stories in height or to one story Type ‘A’ buildings. They shall enclose at least one, but no more than two ATTIC STORIES of habitable space as indicated in the BUILDING ENVELOPE STANDARDS;

[2] Only dormer windows are permitted in mansard roofs. Windows, balconies and other features that are recessed into the mansard are prohibited. Dormers and other architectural features shall occupy a minimum of 25% of the roof length;

[3] A cornice or similar architectural feature shall form a transition between the mansard and the vertical building wall. No part of the mansard, including dormers, shall project beyond the building FAÇADE wall;

[4] A transitional architectural feature shall be provided between the top of the mansard and the upper part of the roof.

- *Mansards should be used only when emulating a traditional building style that typically employs mansard roofs, e.g. Beaux Arts, Victorian, etc.*

(c) Skylights

Skylights shall be flat to the pitch of the roof.

(d) Permitted (visible) Roofing Materials

[1] Standing Seam or Five Vee metal roofs of galvanized steel, copper, aluminum or zinc-aluminum;

[2] Asphalt or metal “dimensional” type shingles;

[3] Cedar shakes (real or synthetic);

[4] Slate tiles (real or synthetic)

[5] Clay, terra cotta or concrete tiles;

[6] 'Green' roofs on flat roofs only;

[7] Roofing materials including shingles and metal panels that incorporate photovoltaic solar collectors.

(6) Projecting Façade Elements

(a) Awnings and Canopies



Where awnings or canopies are provided, they shall comply with the following:

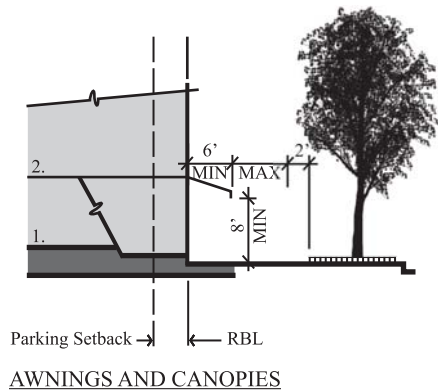

[1] Minimum 8 feet clear above sidewalk, minimum 6 feet projection from building, maximum projection 2 feet from tree planters or grates, or 2 feet from curb line where no trees are present;

[2] Where encroaching into a public right-of-way, subject to Department of Environmental Services approval;

[3] Canvas cloth or equivalent (shiny or reflective materials are prohibited), metal or glass;

[4] Internal illumination is prohibited;

[5] One-quarter cylinder configurations are prohibited.



(b) Galleries



GALLERIES are permitted along building FAÇADES where the REQUIRED BUILD-TO LINE (RBL) or REQUIRED FRONTAGE ZONE (RFZ) abuts the required CIVIC SQUARE or does not abut a public right-of-way, provided they comply with the following:

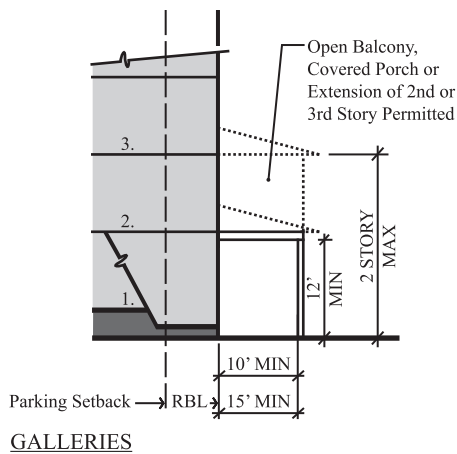

[1] Minimum width of 10 feet;

[2] GALLERIES shall have a roof, an open BALCONY, a covered porch or an extension of the story above. Where there is a covered porch or an extension of an upper story, the building shall have at least one additional story above that level. Where there is an extension of an upper story, the FAÇADE of the story extension shall have fenestration with areas of transparency equal to at least 50% but no more than 90% of the FAÇADE area;

[3] Minimum ceiling height 12 feet clear above sidewalk, but never less than one foot below ceiling height of adjacent GROUND STORY, 2 story maximum height;

[4] The distance between columns or piers shall not exceed their height. Minimum spacing is 10 feet.

- *The location of columns or piers is encouraged to correspond with storefront openings.*

(c) Porches and Balconies



Porches and BALCONIES shall comply with the following:

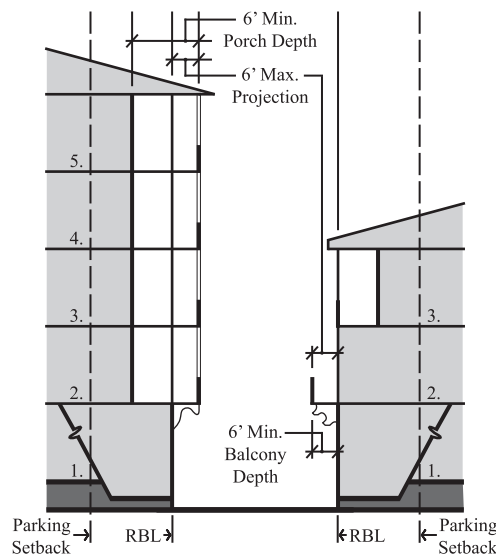

PORCHES AND BALCONIES

[1] Porches and BALCONIES may occur at upper stories either forward of or behind the RBL or RFZ and shall have a minimum depth of 6 feet, but shall not extend more than 6 feet beyond the RBL except at the upper level of a GALLERY;

[2] Porches may occur at the GROUND STORY along non-commercial frontages, either forward of or behind the RBL or RFZ and shall have a minimum depth of 8 feet, but shall not extend into the public right-of-way;

[3] Porches and BALCONIES may have multi-story verandas and/or BALCONIES above;

[4] Porches and BALCONIES may have roofs, but shall be open parts of buildings with no conditioned air supply. Insect screening is permitted.

[5] The minimum distance between columns is 10 feet, and the distance between columns shall not exceed their height.

- *Porches and BALCONIES are encouraged at upper story locations in order to take advantage of views and breezes.*



(d) Stoops



Stoops are permitted along Non-Commercial frontages provided they comply with the following:

- [1] Minimum depth 6 feet;
- [2] Minimum length 5 feet;
- [3] Maximum length 8 feet;
- [4] Stoops may be covered or uncovered;
- [5] Stoops may occur forward of the RBL or RFZ and may encroach into the public right-of-way subject to approval from the Department of Environmental Services. Stoops shall not interfere with clear access for Pedestrians on the sidewalk.

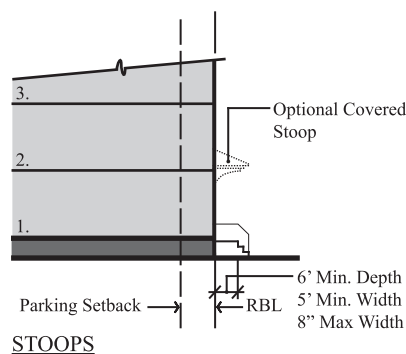

(e) Finish Materials

The following finish materials are permitted for porches, stoops, columns, arches, railings and balustrades:

- [1] Painted finish wood;
- [2] Solid PVC paintable or prefinished trim boards (such as Azek or equivalent). Wood grain finishes are not permitted;
- [3] Painted or stainless steel;
- [4] Cast iron;
- [5] Concrete with smooth finish;
- [6] Brick or stone masonry.

(f) Bay Windows



BAY WINDOWS are permitted provided they comply with the following:

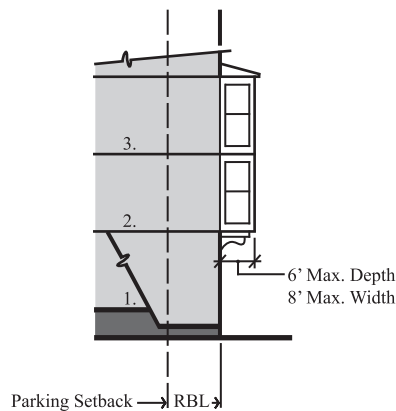

BAY WINDOWS

[1] Maximum depth 6 feet;

[2] Maximum length 8 feet;

[3] BAY WINDOWS shall have FENESTRATION on both front and side surfaces;

[4] BAY WINDOWS may occur forward of the RBL or RFZ and may encroach into the public right-of-way above the GROUND STORY subject to approval from the Department of Environmental Services.

(7) Signage**(a) Alternate Sign Program**

No signs shall be approved within the Marina District unless an alternative sign program in compliance with §120-177K has been established for the building where the proposed sign will be located.

G

Review & Approval Process

M-D Marina District

This page intentionally left blank.

G. Review and Approval Process

(1) Construction of any new building or addition within the Marina District that does not comply with the requirements of this Section shall be categorized as a major site plan and subject to the requirements set forth in §120-191 of this chapter. The Director of Planning and Zoning may waive the requirements of the Marina District through the site plan approval process upon a determination that a project is in substantial compliance with the overall intent and purpose of the Marina District except for the following:

(a) Any deviation from the REGULATING PLAN including location of the REQUIRED BUILD-TO LINE (RBL), location of REQUIRED FRONTAGE ZONE, location of PARKING SETBACK LINE, location of allowable areas for parking/loading ingress/egress, location of mandatory commercial frontage and location of permitted building types;

(b) Any deviation from the minimum or maximum dimensional requirements of the BUILDING ENVELOPE STANDARDS, or the maximum building height requirements measured in stories, that is greater than 20%;

(c) Any deviation from the Siting requirements of the BUILDING ENVELOPE STANDARDS other than deviations from the percentage of the FAÇADE built to the REQUIRED BUILD-TO LINE (RBL) that are greater than 20% and deviations from the dimensional requirements for tower siting in Building Type C that are greater than 20%;

(d) Any deviation from the Building Function (Use) Standards;

(e) Any deviation from minimum or maximum dimensional requirements of the CIVIC SQUARE Standards that is greater than 20%;

(f) Any deviation from the minimum or maximum dimensional requirements and numerical requirements of the Parking and Loading Standards that is greater than 10%;

(g) Any deviation from the Architectural Standards requirement for an alternative sign program.

(2) Any development proposal that will cause the total number of dwelling units in the Marina District to exceed 430 and/or cause the total amount of commercial space in the District, not including existing commercial space in the Terminal Building, to exceed 44,000 square feet, shall require a Supplemental Environmental Impact Statement pursuant to the requirements of the State Environmental Quality Review Act and Chapter 48 of the City Code.

This page intentionally left blank.

H

Definitions

M-D Marina District

This page intentionally left blank.

H. Definitions

Attic Story. Habitable space situated within the structure of a pitched roof and above the uppermost story. They are permitted for all Building Types and do not count against the maximum story height. Attic stories may have only DORMERS as windows on the REQUIRED BUILD-TO LINE (RBL) side of the roof-pitch.

Balcony. An exterior platform attached to the upper stories of the building FAÇADE.

Bay Window. An enclosure extending the interior space of the building beyond the exterior building FAÇADE. For the purposes of this code, a BAY WINDOW may be generally u-shaped, curved (also known as a bow window) or rectangular.

Block Corner. The outside corner of a block at the intersection of any two streets. Dimensions from BLOCK CORNERS are measured from the intersection of two RBL's.

Building Envelope Standards. The part of this Section that establishes basic parameters regulating building form, including the envelope (in three dimensions), placement and certain permitted/required building elements, such as storefronts, BALCONIES, and STREET WALLS. The BUILDING ENVELOPE STANDARDS establish both parameters and specific requirements. The applicable building envelope standard for a site is determined by the allowable building types indicated on the REGULATING PLAN. This produces a coherent street-space and allows the building owner greater latitude behind its FAÇADE.

Civic Square. A public open space designated on the REGULATING PLAN. The term square is generally used to describe spaces that have a predominately paved surface area. CIVIC SQUARES do not include active recreation structures such as playgrounds or game courts.

Dormers. Roofed ancillary structures with windows providing light and air to habitable space within the ATTIC STORY. DORMERS are permitted and the attic does not constitute a story (for height measurement purposes) so long as the DORMERS do not break the primary eave line, are individually less than 15 feet wide, and are collectively not more than 60 percent of their REQUIRED BUILD-TO LINE FAÇADE length.

Façade (Building Face). The building elevation facing the public right-of-way or required CIVIC SQUARE, generally coinciding with the REQUIRED BUILD-TO LINE or required step backs. Building walls facing private interior spaces are not FAÇADES.

Fenestration. Openings in the building wall, including windows and doors, allowing light and views between interior (private realm) and exterior (public realm). FENESTRATION is measured as glass area (including mullions and similar window frame elements) and/or as open area.

Gallery. A Lightweight roof structure or BALCONY supported by columns and attached to the building frontage to provide shelter to the sidewalk.

Ground Story. The first habitable level of a building at or above grade. For commercial frontages, at least two-thirds of the finished floor elevation within 30 feet of the required building line shall be within 18 inches of the adjacent fronting sidewalk level. When a residential use occupies the GROUND STORY, the finished floor shall be at least three feet, but never more than six feet above the fronting sidewalk elevation. The next story above the GROUND STORY is the second story.

Parcel. Where this term is used in §120-77.2, it refers exclusively to PARCELS I, II and III as indicated on the REGULATING PLAN. PARCELS may be subdivided into separate building lots in accordance with Chapter 128. Subdivisions do not affect any provisions of this section relating to PARCELS.

Parking Setback Line. A line or plane indicated on the REGULATING PLAN which extends vertically (unless otherwise noted) and is generally parallel to the REQUIRED BUILD-TO LINE (RBL) or REQUIRED FRONTAGE ZONE (RFZ). The parking setback is typically 30 feet behind the RBL, or the actual FAÇADE of the building where there is an RFZ, unless otherwise designated on the REGULATING PLAN. All parking shall be situated behind this line, except where it is entirely below grade. The PARKING SETBACK LINE is a permissive minimum and parking may be placed anywhere within the lot behind this line.

Regulating Plan. The implementing plan for the development of the Marina District. The REGULATING PLAN indicates the allowable building types, allocates space for the required CIVIC SQUARE and provides specific information for vehicular access to each PARCEL.

Required Build-To Line (RBL). A line or vertical plane indicated on the REGULATING PLAN, defining the street frontage which extends vertically and generally parallel to the street, at which the building shall be placed. The FAÇADE shall occur on the REQUIRED BUILD-TO LINE - this is a requirement, not a permissive minimum. The minimum length and height of frontage that is required at the RBL is shown on the appropriate Building Envelope Standard.

Required Frontage Zone (RFZ). A horizontal plane indicated on the REGULATING PLAN, defining the area within which the building FAÇADE must be placed. The FAÇADE shall occur within the REQUIRED FRONTAGE ZONE – this is a requirement that allows for a greater range of options on those PARCELS where the RFZ is instituted in place of the RBL. These are PARCELS where definition and enclosure of the street space are of lesser importance, therefore wider latitude is given.

Street Wall. A masonry wall set back not more than 24 inches from the required building line which assists in the definition of the street-space in the absence of a building. See the General Provisions of the BUILDING ENVELOPE STANDARDS for height specifications.